

Instructions for installation and use

WASHING MACHINE

EN

English, 1

AQUALTIS

AQLF9F 49 U

Contents

Installation, 2-3-4-5

Unpacking and levelling
Connecting the electricity and water supplies
Technical data

Description of the machine, 6-7

Control panel

Auto Dose System, 8-9

Running a wash cycle, 10

Wash cycles and options, 11

Table of wash cycles
Wash options

Detergents and laundry, 12

Detergent
Preparing the laundry
Washing recommendations
Load balancing system

Precautions and advice, 13

General safety
Disposal
Opening the porthole door manually

Care and maintenance, 14

Cutting off the water and electricity supplies
Cleaning the machine
Cleaning the detergent dispenser drawer
Caring for your appliance drum
Cleaning the pump
Checking the water inlet hose

Trouble shooting, 15-16-17

Assistance, 18-19

EN

Installation

EN

! This instruction manual should be kept in a safe place for future reference. If the washing machine is sold, given away or moved, please ensure the manual is kept with the machine, so that the new owner may benefit from the advice contained within it.

! Read these instructions carefully: they contain vital information relating to the safe installation and operation of the appliance.

! Inside the pack containing this manual, you will also find the guarantee and all the details necessary for installation.

Unpacking and levelling

Unpacking

1. Once you have removed all the packaging from the washing machine, make sure it has not been damaged during transportation.

If it has been damaged, contact the retailer and do not proceed any further with the installation process.

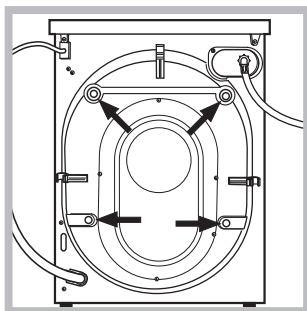

2. Remove the 4 protective screws (used during transportation) and the corresponding spacer, located on the rear part of the appliance (see figure).

3. Close off the holes using the plastic plugs supplied in the pack.

4. Keep all the parts in a safe place; **they will be needed again if the washing machine is moved to another location, to prevent the inside of the appliance being damaged.**

! Packaging materials should not be used as toys for children.

Levelling

1. Place the washing machine on a flat sturdy floor, without resting it up against walls or cabinets.

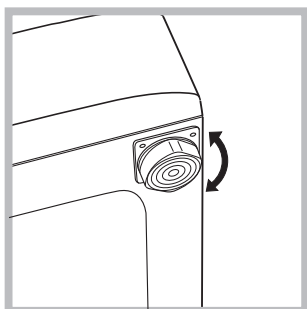

2. If the floor is uneven, the front feet of the machine may be adjusted until it reaches a horizontal position (the angle of inclination must not exceed 2 degrees).

! If the appliance is levelled correctly, it will be more stable and much less likely to cause vibrations and noise while it is operating, particularly during the spin cycle.

! If it is placed on carpet or a rug, adjust the feet in such a way as to allow a sufficient ventilation space underneath the washing machine.

Connecting the electricity and water supplies

Connecting the water inlet hose

! Before connecting the inlet hose to the water supply, run the water until it is perfectly clear.

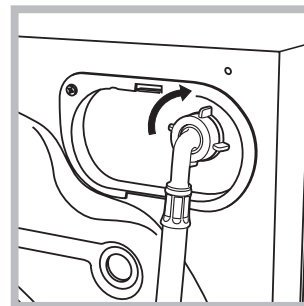

1. Connect the inlet hose to the machine by screwing it onto the cold water inlet of the appliance, which is situated on the top right-hand side of the rear part of the appliance (see figure).

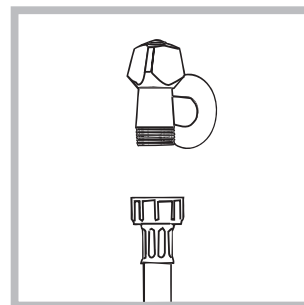

2. Connect the inlet hose by screwing it to a cold water tap using a 3/4 gas threaded connection (see figure).

3. Make sure that the hose is not folded over or bent.

! The water pressure at the tap must fall within the values indicated in the Technical data table (see next page).

! If the inlet hose is not long enough, contact a specialised shop or an authorised technician.

! Never use second-hand or old inlet hoses; use the products supplied with the machine.

Connecting the drain hose

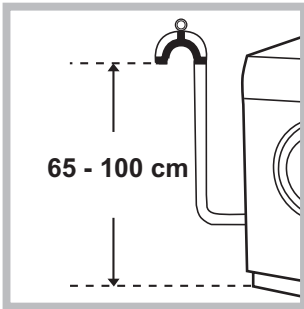

Connect the drain hose, without bending it, to a draining duct or a wall drain situated between 65 and 100 cm from the floor;

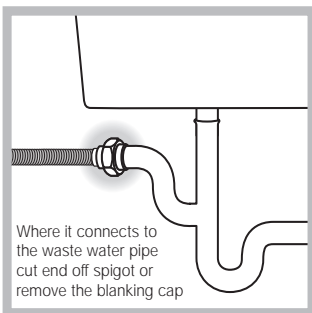

The drain hose may be connected to an under-sink trap. Before connecting the drain hose from the machine ensure that any blanks or removable ends have been taken off the spigot.

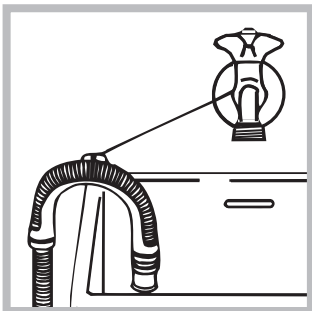

If it is placed over the edge of a basin or sink be sure the free end of the hose should not be underwater.

! We advise against the use of hose extensions; in case of absolute need, the extension must have the same diameter as the original hose and must not exceed 150 cm in length.

Ensure that if the drain hose is pushed into a standpipe, that the end does not go down more than 15cms (6 inches). If the hose is pushed down too far, this may cause the machine to self-siphon ie. continuously empty as it is filling.

Electric connection

Before plugging the appliance into the mains socket, make sure that:

- the socket is earthed and in compliance with the applicable law;
- the socket is able to sustain the appliance's maximum power load indicated in the Technical details table (see page 5);

- the supply voltage is included within the values indicated on the Technical details table (see page 5);

- the socket is compatible with the washing machine's plug. If this is not the case, replace the socket or the plug.

Your appliance is now supplied with a 13 amp fused plug it can be plugged into a 13 amp socket for immediate use. Before using the appliance please read the instructions below.

WARNING - THIS APPLIANCE MUST BE EARTHED. THE FOLLOWING OPERATIONS SHOULD BE CARRIED OUT BY A QUALIFIED ELECTRICIAN.

Replacing the fuse:

When replacing a faulty fuse, a 13 amp ASTA approved fuse to BS 1362 should always be used, and the fuse cover re-fitted. If the fuse cover is lost, the plug must not be used until a replacement is obtained.

Replacement fuse covers:

If a replacement fuse cover is fitted, it must be of the correct colour as indicated by the coloured marking or the colour that is embossed in words on the base of the plug. Replacements can be obtained directly from your nearest Service Depot.

Removing the plug:

If your appliance has a non-rewireable moulded plug and you should wish to re-route the mains cable through partitions, units etc., please ensure that either: the plug is replaced by a fused 13 ampere rewireable plug bearing the BSI mark of approval.

or:

the mains cable is wired directly into a 13 amp cable outlet, controlled by a switch, (in compliance with BS 5733) which is accessible without moving the appliance.

Disposing of the plug:

Ensure that before disposing of the plug itself, you make the pins unusable so that it cannot be accidentally inserted into a socket.

Instructions for connecting cable to an alternative plug: Important: the wires in the mains lead are coloured in accordance with the following code:

Green & Yellow	Earth
Blue	Neutral
Brown	Live

As the colours of the wires in the lead may not correspond with the coloured markings identifying the terminals in your plug, proceed as follows:

Connect Green & Yellow wire to terminal marked **E** or \equiv or coloured Green or Green & Yellow.

Connect Brown wire to terminal marked **L** or coloured Red.

Connect Blue wire to terminal marked **N** or coloured Black.

If a 13 amp plug (BS 1363) is used it must be fitted with a

13 amp fuse, either in the plug or adaptor or at the distribution board.

If you are in any doubt about the electrical supply to your machine, consult a qualified electrician before use.

How to connect an alternative plug:

The wires in this mains lead are coloured in accordance with the following code:

BLUE	NEUTRAL (N)
BROWN	LIVE (L)
GREEN & YELLOW	EARTH (E)

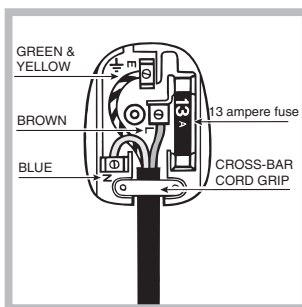

Disposing of the appliance:

When disposing of the appliance please remove the plug by cutting the mains cable as close as possible to the plug body and dispose of it as described above.

! The washing machine should not be installed in an outdoor environment, not even when the area is sheltered, because it may be very dangerous to leave it exposed to rain and thunderstorms.



! When the washing machine is installed, the mains socket must be within easy reach.

! Do not use extensions or multiple sockets.

! The power supply cable must never be bent or dangerously compressed.

! The power supply cable must only be replaced by an authorised serviceman.

Warning! The company denies all liability if and when these norms are not respected.

Technical data	
Model	AQLF9F 49 U
Dimensions	width 59.5 cm height 85 cm depth 64,5 cm
Capacity	from 1 to 9 kg
Electrical connections	please refer to the technical data plate fixed to the machine
Water connections	maximum pressure 1 MPa (10 bar) minimum pressure 0.05 MPa (0.5 bar) drum capacity 62 litres
Spin speed	up to 1400 rotations per minute
Energy rated programmes according to regulation 2010/1061	programme  ; temperature 60°C and 40°C.
 	This appliance conforms to the following EC Directives: - 2004/108/EC (Electromagnetic Compatibility) - 2006/95/EC (Low Voltage) - 2002/96/EC

Description of the machine

EN

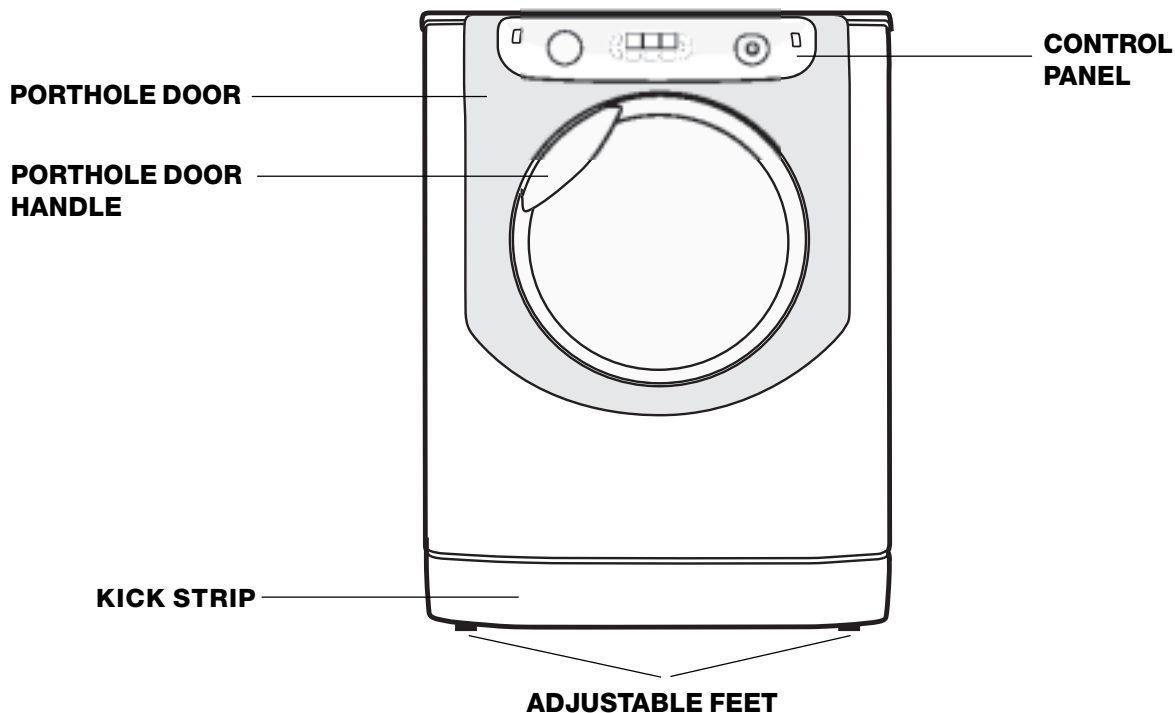

PORTHOLE DOOR



Always use the handle to open the porthole door (see figure).

Standby mode

This washing machine, in compliance with new energy saving regulations, is fitted with an automatic standby system which is enabled after about 30 minutes if no activity is detected. Press the ON-OFF  button briefly and wait for the machine to start up again.

DETERGENT DISPENSER DRAWER

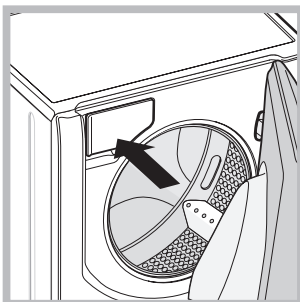

The detergent dispenser drawer is located inside the machine and can be accessed by opening the door. Refer to the chapter "*Auto Dose System*" for information on operation.

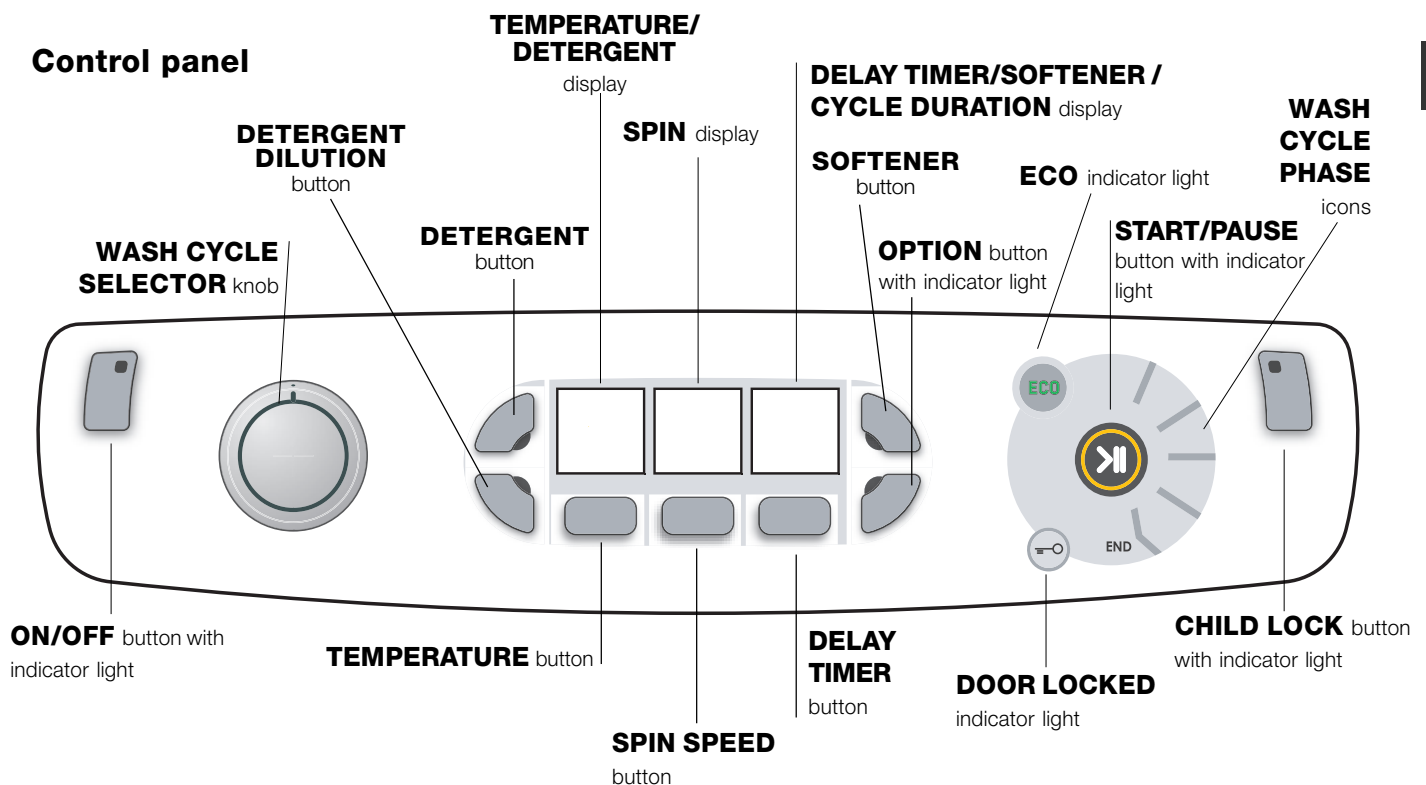

Button with **ON/OFF** indicator light: press this briefly to switch the machine on or off. The green indicator light indicates that the machine is switched on. To switch off the washing machine during the wash cycle, press and hold the button for approximately 3 seconds; if the button is pressed briefly or accidentally the machine will not switch off. If the machine is switched off during a wash cycle, this wash cycle will be cancelled.

WASH CYCLE SELECTOR knob: may be turned in either direction. To select the most suitable wash cycle, please refer to the "Table of wash cycles". The knob will not move during the wash cycle.

TEMPERATURE button: press to modify or exclude the temperature setting; the value selected will appear on the display above (see "Running a wash cycle").

SPIN SPEED CYCLE button: press to modify or exclude the spin cycle; the value selected will appear on the display above (see "Running a wash cycle").

DELAY TIMER button: press to set a DELAY TIMER for the selected wash cycle; the set delay time will appear on the display above (see "Running a wash cycle").

DETERGENT and **SOFTENER** buttons: refer to "Modifying pre-set parameters" in the chapter "Auto Dose System".

DETERGENT DILUTION button: refer to "Filling the tanks" in the chapter "Auto Dose System".

OPTION button with indicator light: press to select the available options. The indicator light corresponding to the selected option will remain lit (see "Running a wash cycle").

WASH CYCLE PHASE icons: these illuminate to indicate the progress of the wash cycle (Wash – Rinse – Spin – Drain). The text **END** lights up when the cycle is complete.

START/PAUSE button with indicator light: when the green indicator light flashes slowly, press the button to start a wash cycle. Once the cycle has begun the indicator light will remain lit in a fixed manner. To pause the wash cycle, press the button again; the indicator light will flash in an orange colour. If the "Door locked" indicator light is switched off, the door may be opened. To start the wash cycle from the point at which it was interrupted, press the button again.

DOOR LOCKED indicator light: indicates that the porthole door is locked. To open the door, pause the wash cycle (see "Running a wash cycle").

CHILD LOCK button with indicator light: to activate or deactivate the CHILD LOCK, press and hold the button for approximately 2 seconds. when the indicator light is illuminated, the control panel is locked. This means it is possible to prevent wash cycles from being modified accidentally, especially where there are children in the home.

ECO indicator light: the **ECO** icon lights up when, after altering the washing parameters, an energy saving of at least 10% is made. Furthermore, before the machine enters "Standby" mode, the icon will light up for a few seconds; when the machine is switched off the estimated energy saving will be around the 80% mark.

Auto Dose System

EN

Introduction

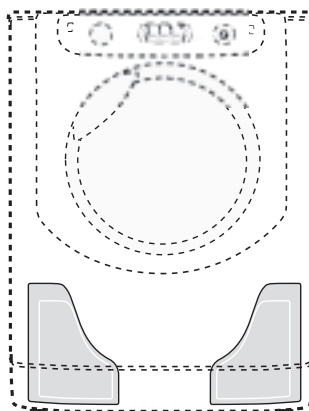

This washing machine is equipped with two tanks: one for liquid detergent (either concentrated or diluted) with a capacity of approx. 5.5 l and another for liquid fabric softener (either concentrated or diluted) with a capacity of approx. 3.5 l (see picture).

! Check the detergent/fabric softener box to verify whether it is diluted or concentrated detergent. The automatic dosing system intakes the

correct amount of detergent and fabric softener from the tanks for each type of load and at the right time, guaranteeing optimal washing results without wastage. The amount of detergent/fabric softener can be modified manually by pressing the DETERGENT and FABRIC SOFTENER buttons (refer to "Modifying pre-set parameters"). If you prefer, the washing machine can also be used in the "traditional" mode, i.e. by adding the detergent in the dispenser; the machine will automatically detect the detergent and will not use the tanks.

Detergent dispenser

"Traditional" mode.

Pull out the detergent dispenser drawer up to the first stop point to add the detergent (either liquid or powder detergent), bleach or other additives (e.g. whiteners) and the pre-wash detergent for washing in the "traditional" mode (refer to "Traditional" mode).

"Auto Dose System" mode.

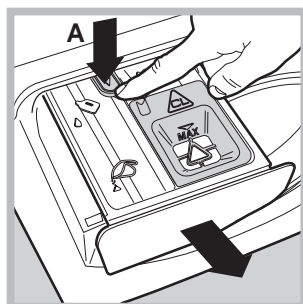

In order to fill the **detergent and fabric softener tanks, the detergent dispenser drawer must be fully extracted**: open the dispenser drawer up to the first stop point then press the lever (A) and open up to the second stop point, **making sure that it is fully extracted. Avoid**

moving the dispenser drawer during filling operations.

Once the tanks have been filled (refer to "Filling the tanks"), the machine can run up to 40 cycles before the detergent finishes (*).

First-time use

Turn the washing machine on by pressing the ON/OFF button. The first wash cycle must be carried out without laundry and by adding detergent in the detergent dispenser (refer to "Traditional" mode); set the programme "Cotton 90°" without pre-wash and without filling the tanks.

Filling the tanks:

Open the detergent dispenser drawer in the "Auto Dose System" mode (refer to "Detergent dispenser"). Slowly pour the detergent (B) and fabric softener (C) until the tanks are completely filled (see picture).

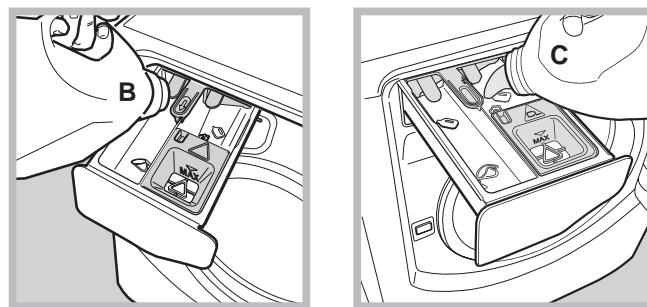

To avoid exceeding the maximum capacity, a buzzer (beep) will sound with growing intensity to signal the level and 3 long beeps will sound once the tank is completely full. Start the wash cycle immediately after filling the tanks to ensure that the dispenser is properly cleaned. The respective icons (for the detergent) and (for the fabric softener) will light up gradually to signal the level.

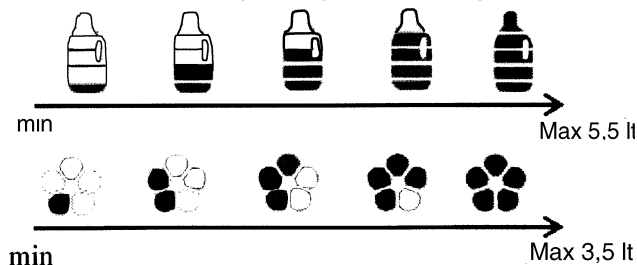

The filling time depends on the density of the product. Very dense products will take longer to fill.

Close the detergent dispenser drawer only once the compartments are completely empty.

Select the density of the detergent added (either concentrated or liquid) by pressing the appropriate button.

The machine will store the selection.

If no option is selected, the detergent intake option will be pre-set to "diluted".

Use button to set the amount of fabric softener that will be automatically extracted by the machine:

- 1) If concentrated softener is used, we recommend selecting the first level (with one bar) and, if necessary, stepping up by a single position (with 2 bars) to increase detergent intake.
- 2) If diluted softener is used, we recommend setting level 3 (with 3 bars) and to then either increase/decrease the amount of fabric softener to be extracted.
- 3) To exclude the use of fabric softener, press until the bars disappear (also refer to "Modifying pre-set parameters").

(*) with an average load of 4 kg, 40°C Cotton programme, "medium" water hardness level and dirt level set to 3.

Signals for successive refilling:

When the level of detergent/fabric softener falls below the required level, at the end of the cycle, the first segment of the detergent symbol or the petal of the fabric softener symbol in the bottom left section, will flash slowly on the display. Once the detergent/fabric softener is finished, the first segment of the detergent symbol or the petal of the fabric softener symbol in the lower left section will flash fast to signal that the detergent or fabric softener tank is empty. While the cycle runs, with empty tanks, the symbols will disappear; at the end of the cycle or during the pause mode, the first segment of the symbol and the petal of the symbol in the lower left section will flash fast. If the tanks are not filled, the successive wash cycles in *Auto Dose System* will be carried out without any intake of detergent.

! We suggest adding detergent and fabric softener ONLY after the machine's signal.

! NEVER mix two different detergents; always clean out the tank before adding a new type of detergent (refer to "Cleaning cycle set by the user").

Using the "Auto Dose System"

If the compartments have been filled with detergent and fabric softener, you may start using the machine (refer to "Running a wash cycle").

Powder detergents for pre-washing and powder additives may only be used in the traditional mode or using the "Auto Dose System", by placing the additives directly inside the drum, preferably in conjunction with the "laundry ball".

Modifying pre-set parameters:

The machine automatically intakes detergent on the basis of the selected programme, wash load and water hardness. However, the amount of detergent/fabric softener used may be modified.

button: press to increase, decrease and to exclude detergent intake.



button: press to increase, decrease and to exclude fabric softener intake.



The level of detergent/fabric softener suggested by the machine is indicated by 3 bars.

Less than 3 bars indicates a lower level of detergent/fabric softener compared to that suggested by the machine, while more than 3 bars indicates a higher level of detergent/fabric softener.

Cleaning the tanks:

Tank cleaning cycles can either be automatic or pre-set by the user.

Automatic cleaning:

The washing machine carries out an automatic cleaning cycle during the rinse cycle if the level of detergent that remains is insufficient for carrying out a successive wash cycle.

Cleaning cycle set by the user:

Run the cleaning cycle (with empty drum) if you require adding a different product to the previous one or if the tanks have been incorrectly filled (e.g. fabric softener has been erroneously poured into the detergent tank or vice-versa). Press button and hold for approximately 8 sec. to activate cleaning of the detergent tank, button for cleaning the fabric softener tank or button for cleaning both tanks. Once the buzzers with growing intensity are followed by 2 long buzzers and the icons for the detergent, for the fabric softener, for both tanks appear, the cleaning cycle for the selected container will start.

The cleaning cycle lasts about **40'** if the tanks are initially empty; if not, the cycle will last longer.

! During the tank cleaning cycle, the symbol will fill gradually from bottom to top and the symbol will fill gradually petal by petal.

"Traditional" mode

Pull out the detergent dispenser drawer up to the first stop point (see picture) then pour the amount of detergent and other additives (e.g. bleach) required for a single wash cycle directly into the dispenser.

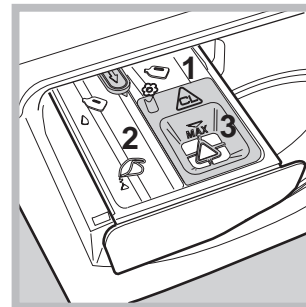

1. *pre-wash compartment:* use powder detergent **only**.

2. *main wash compartment:* use powder or liquid detergent. If the latter is used, we recommend pouring it into the dispenser immediately before starting the washing machine and without

running a pre-wash cycle.

3. **! Do not pour anything in this compartment.**

Tablet detergent or the relative "laundry ball" must be added directly inside the drum. In this event, deactivate the "Auto Dose System" (by pressing the button until the relative vertical bars disappear from the display).

Do not pour any fabric softener as the appropriate quantity required for each wash cycle will be automatically extracted.

To deactivate fabric softener intake, press the button until the vertical bars disappear from the display.

For wool and silk garments, we recommend using a special detergent which must be poured directly into the detergent dispenser (compartment 2).



Running the wash cycle:

Select the programme and the compatible options on the basis of the required need and type of load.





Running a wash cycle

EN

WARNING: before you use the washing machine for the first time, run a wash cycle with detergent and no laundry, using the 90° cottons cycle without pre-wash.



1. **SWITCH THE MACHINE ON.** Press the  button. All the indicator lights will illuminate for 1 second; the indicator light corresponding to the  button will then remain lit in a fixed manner and the START/PAUSE indicator light will flash slowly.
2. **LOAD THE LAUNDRY.** Open the porthole door. Load the laundry, making sure you do not exceed the maximum load value indicated in the table of wash cycles on the following page.
3. **MEASURE OUT THE DETERGENT.** There is no need to add detergent when the "Auto Dose System" mode is used, as the machine automatically intakes detergent on the basis of the selected programme, type of load and water hardness. Refer to the paragraph "Traditional" mode for implementing the traditional operation mode.
4. **CLOSE THE PORTHOLE DOOR.**
5. **SELECT THE PROGRAMME.** Turn the WASH CYCLE SELECTOR KNOB right or left, until you have selected the desired wash cycle. A temperature and spin speed is set for each wash cycle; these may be adjusted.
6. **CUSTOMISE THE WASH CYCLE.** Use the relevant buttons on the control panel:

Modify the temperature and/or spin speed.

The machine automatically displays the maximum temperature and spin speed values set for the selected cycle, or the most recently-used settings if they are compatible with the selected cycle. The temperature can be decreased by pressing the  button, until the cold wash () setting is reached. The spin speed may be progressively reduced by pressing the  button, until it is completely excluded (). If these buttons are pressed again, the maximum values are restored.

! Exception: if the "Cotton" programme is selected, the temperature can be increased up to a value of 90°C.

Set a DELAY TIMER.

Press the button until you have reached the desired delay time. During the setting process, the delay time is shown on the display and the  symbol flashes. After selecting a DELAY TIMER time, the fixed  symbol and the cycle duration will appear on the display. Press the button once to display the selected delay time. To remove the DELAY TIMER option,

press the button until the display shows the text OFF; the  symbol will disappear.



! Once the START/PAUSE button has been pressed, the time delay may only be decreased.

Modify the cycle settings.

Press the OPTION button to customise the wash cycle in accordance with your own requirements.

- Press the button to activate the option; the corresponding indicator light will switch on.
- Press the button again to disable the option; the indicator light will switch off.

! If the selected option is not compatible with the selected wash cycle, this incompatibility will be signalled by the flashing of the indicator light and a sound alert (3 beeps); the option will not be activated.

7. **START THE PROGRAMME.** Press the START/PAUSE button. The corresponding indicator light remains lit in a fixed manner and the porthole door locks (the  DOOR LOCKED indicator light illuminates). The icons corresponding to the wash cycle phases will light up during the cycle to indicate which phase is currently in progress. To change a wash cycle once it has already started, pause the washing machine by pressing the START/PAUSE button; then select the desired cycle and press the START/PAUSE button again. To open the door during a wash cycle, press the START/PAUSE button; if the DOOR LOCKED  indicator light is switched off you may open the door. Press the START/PAUSE button again to restart the wash cycle from the point at which it was interrupted.
8. **THE END OF THE WASH CYCLE.** This is indicated by the illuminated text **END**. The porthole door may be opened immediately. If the START/PAUSE indicator light is flashing, press the button to end the cycle. Open the door, unload the laundry and switch off the machine.

! If you wish to cancel a cycle which has already begun, press and hold the  button until the cycle stops and the machine switches off.

Bag for quilts, curtains and delicate garments

The Aqualtis washing machine makes it easier for you to wash even the most valuable and delicate garments in complete confidence thanks to the special bag which protects the laundry (this is supplied with the machine). We recommend that the bag is used every time you wash quilts and padded items with an outer layer made using synthetic material.

Table of wash cycles

Icon	Description of the wash cycle	Max. temp. (°C)	Max. speed (rpm)	Detergent and additives			Max. load (kg)	Cycle duration	
				Detergent for prewash	Detergent for wash	Fabric softener			
Cottons wash cycles									
	Cotton with pre-wash <i>(Add detergent to the relevant compartment).</i>	90°	1400	●	●	●	9	(*) The duration of the wash cycles can be checked on the display.	
	Cotton (1-2): heavily soiled whites and resistant colours.	60° (Max. 90°)	1400	-	●	●	9		
	Cotton (2): Lightly soiled whites and delicate colours.	40°	1400	-	●	●	9		
	Coloured Cotton (3)	40°	1400	-	●	●	9		
	Shirts	40°	600	-	●	●	2		
	Jeans	40°	800	-	●	●	4		
Special programmes									
	Baby: heavily soiled delicate colours	40°	800	-	●	●	4		
	Durable Synthetics	60°	800	-	●	●	4		
	Durable Synthetics (4)	40°	800	-	●	●	4		
	Delicate Synthetics	40°	800	-	●	●	4		
	"Bed & Bath" for bedlinen and towels.	60°	1400	-	●	●	9		
	Duvets: for down-stuffed garments.	30°	1200	-	●	●	3,5		
	Silk: for garments in silk and viscose, lingerie.	30°	0	-	●	●	2		
	Wool: for wool, cashmere, etc.	40°	800	-	●	●	2		
	Mix 30*: to refresh lightly soiled garments quickly (not suitable for wool, silk and clothes which require washing by hand)	30°	800	-	●	●	3,5		
Partials wash cycles									
	Rinse	-	1400	-	-	●	9		
	Spin	-	1400	-	-	-	9		
	Drain	-	0	-	-	-	9		

(*) Note: 10 minutes after the START, the machine will recalculate the time remaining until the end of the wash cycle on the basis of the load inside it; this value will then be shown on the display.

The length of cycle shown on the display or in this booklet is an estimation only and is calculated assuming standard working conditions. The actual duration can vary according to factors such as water temperature and pressure, the amount of detergent used, the amount and type of load inserted, load balancing and any wash options selected.

For all Test Institutes:

- 1) Test wash cycle in compliance with regulation 2010/1061: set wash cycle with a temperature of 60°C e 40°C.
- 2) Long wash cycle for cottons: set wash cycle with a temperature of 40°C.
- 3) Short wash cycle for cottons: set wash cycle with a temperature of 40°C.
- 4) Long wash cycle for synthetics: set wash cycle ; with a temperature of 40°C.

Wash options

Detergent dosage

To dose the amount of detergent (refer to the chapter "Auto Dose System").

Concentrated Detergent

To modify the degree of detergent density (refer to the chapter "Auto Dose System").

Fabric softener dosage

To dose the amount of fabric softener (refer to the chapter "Auto Dose System").

Eco Option

The Eco Option saves energy by not heating the water used to wash your laundry – an advantage both to the environment and to your energy bill. Instead, intensified wash action and water optimisation ensure great wash results in the same average time of a standard cycle. For the best washing results we recommend the usage of a liquid detergent.

! It cannot be used in conjunction with , , , , , , , , , .

Detergents and laundry

EN

Detergent

The type and quantity of detergent required depend on the type of fabric you are washing (cotton, wool, silk, etc.), as well as its colour, the washing temperature, the level of soiling and the hardness of the water in the area. Whenever the detergent and fabric softener "Auto Dose System" is activated, this washing machine helps to prevent wastage and to protect the environment, besides guaranteeing optimal washing performance. We recommend the following:

- Use powder detergent for carrying out a pre-wash and pour in the "traditional" mode.
- Use liquid detergents for delicate cotton garments and for all low-temperature wash cycles.
- When activating the "Auto Dose System" mode, use liquid detergent and fabric softeners only. **Never add ultra-concentrated detergents (e.g. "Gel" type detergents or similar).**
- Use gentle liquid detergents for wool and silk garments and pour in the "traditional" mode.

! Never mix two different detergents; always clean out the tank before adding a new type of detergent.

The detergent should be poured into the relevant compartment - or the dispenser placed directly inside the drum - before the wash cycle begins. In the latter case, it will not be possible to select the Cottons with pre-wash cycle.

! Do not use hand washing detergents because these create too much foam.

Preparing the laundry

- Shake out the garments before loading them into the machine.
- Divide the laundry according fabric type (symbol on the washing instruction label) and colour, making sure you separate the coloured garments from the white ones;
- Empty all pockets and check the buttons;
- Do not exceed the values listed in the "Table of wash cycles", which refer to the weight of the laundry when dry.

How much does your laundry weigh?

1 sheet	400-500 g
1 pillowcase	150-200 g
1 tablecloth	400-500 g
1 bathrobe	900-1200 g
1 towel	150-250 g
1 pair of jeans	400-500 g
1 shirt	150-200 g

Washing recommendations

Shirts: use the special "Shirts"  wash cycle to wash shirts in different fabrics and colours to guarantee they receive the best possible care.

Jeans: use the special "Jeans"  wash cycle for all denim garments; turn inside out before washing and use a liquid detergent.

Baby: use the special "Baby"  wash cycle to remove the soiling typically caused by babies, while removing all traces of detergent from nappies in order to prevent the delicate skin of babies from suffering allergic reactions. The cycle has been designed to reduce the amount of

bacteria by using a greater quantity of water and optimising the effect of special disinfecting additives added to the detergent. At the end of the wash cycle, the machine will slowly rotate the drum; to end the cycle press the START/PAUSE button.

Silk: use the special "Silk"  wash cycle to wash all silk garments. We recommend the use of special detergent which has been designed to wash delicate clothes.

Curtains: use the "Silk"  wash cycle. These should be folded and placed inside the bag provided.

Wool: Hotpoint is the only washing machine brand to have been awarded the prestigious Woolmark Platinum Care endorsement (M.0508) by the Woolmark Company, which means that all woollen garments may be washed in the washing machine, even those which state "hand wash only"  on the label. The "Wool" wash cycle can be used to wash all woollen garments in the washing machine while guaranteeing optimum performance.

Duvets: to wash double or single duvets (the weight of which should not exceed 3,5 kg), cushions or clothes padded with goose down such as puffer jackets, use the special "Duvets"  wash cycle. We recommend that duvets are placed in the drum with their edges folded inwards (see figure) and that no more than $\frac{3}{4}$ of the total volume of the drum is used.



Quilts: to wash quilts with a synthetic outer layer, use the bag provided and set the wash cycle to "Duvets" .

Bedlinen and towels: use the "Bed & Bath"  cycle to wash laundry from all over the house; this optimises fabric softener performance and helps you save time and energy. We recommend the use of powder detergent.

Stubborn stains: it is wise to treat stubborn stains with solid soap before washing, and to use the Cottons with pre-wash cycle.

Load balancing system

Before every spin cycle, to avoid excessive vibrations before every spin and to distribute the load in a uniform manner, the drum rotates continuously at a speed which is slightly greater than the washing rotation speed. If, after several attempts, the load is not balanced correctly, the machine spins at a reduced spin speed. If the load is excessively unbalanced, the washing machine performs the distribution process instead of spinning. To encourage improved load distribution and balance, we recommend small and large garments are mixed in the load.

! The machine was designed and constructed in accordance with international safety regulations. The following information is provided for safety reasons and must therefore be read carefully.

General safety

- This appliance is not intended for use by persons (including children) with reduced physical, sensory or mental capabilities, or lack of experience and knowledge, unless they have been given supervision or instruction concerning use of the appliance by a person responsible for their safety. Children should be supervised to ensure that they do not play with the appliance.
- This appliance was designed for domestic use only.
- Do not touch the machine when barefoot or with wet or damp hands or feet.
- Do not pull on the power supply cable when unplugging the appliance from the electricity socket. Hold the plug and pull.
- Do not touch the drained water as it may reach extremely high temperatures.
- Never force the porthole door. This could damage the safety lock mechanism designed to prevent accidental opening.
- If the appliance breaks down, do not under any circumstances access the internal mechanisms in an attempt to repair it yourself.
- Always keep children well away from the appliance while it is operating.
- If it must be moved, proceed with the help of two or three people and handle it with the utmost care. Never try to do this alone, because the appliance is very heavy.
- Before loading laundry into the washing machine, make sure the drum is empty.

Disposal

- Disposing of the packaging materials: observe local regulations so that the packaging may be re-used.
- The European Directive 2002/96/EC relating to Waste Electrical and Electronic Equipment (WEEE) states that household appliances should not be disposed of using the normal solid urban waste cycle. Exhausted appliances should be collected separately in order to optimise the cost of re-using and recycling the materials inside the machine, while preventing potential damage to the atmosphere and to public health. The crossed-out dustbin is marked on all products to remind the owner of their obligations regarding separated waste collection.

For more information relating to the correct disposal of household appliances, owners should contact their local authorities or appliance dealer.

EN

Opening the porthole door manually

In the event that it is not possible to open the porthole door due to a powercut, and if you wish to remove the laundry, proceed as follows:

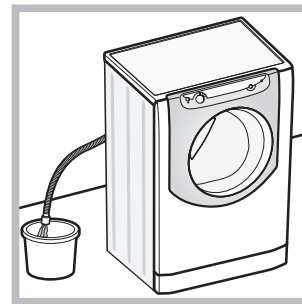

1. remove the plug from the electrical socket.
2. make sure the water level inside the machine is lower than the door opening; if it is not, remove excess water using the drain hose, collecting it in a bucket as indicated in the *figure*.

3. remove the cover panel on the lower front part of the washing machine (*see overleaf*).

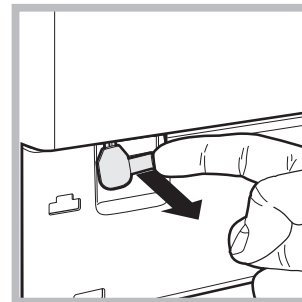

4. pull outwards using the tab as indicated in the figure, until the plastic tie-rod is freed from its stop position; pull downwards until you hear a “click”, which indicates that the door is now unlocked.

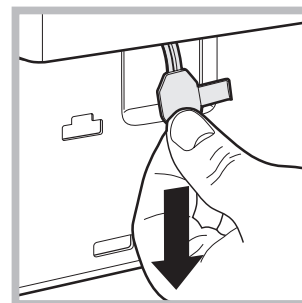

5. open the door; if this is still not possible repeat the procedure.

6. reposition the panel, making sure the hooks are securely in place before you push it onto the appliance.

Care and maintenance

EN

Cutting off the water and electricity supplies

- Turn off the water tap after every wash cycle. This will limit wear on the hydraulic system in the machine and help to prevent leaks.
- Unplug the appliance when cleaning it and during all maintenance work.

Cleaning the machine

The outer parts and rubber components of the appliance can be cleaned using a soft cloth soaked in lukewarm soapy water. Do not use solvents or abrasives.

Cleaning the detergent dispenser drawer

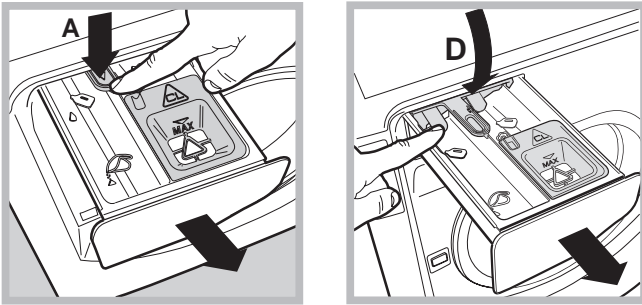

To pull out the dispenser drawer, open until the first stop point then press lever **A** to open completely; finally, press one of the levers **D** and pull the drawer outwards (see picture).

Wash it under running water; this procedure should be effected regularly. Be careful to remove any detergent residues from the dispenser drawer socket on the machine.

Keep the drawer to the left hand side when replacing it to ensure that it centres the guides and to prevent it from jamming.

Caring for your appliance drum

- Always leave the door ajar to prevent unpleasant odours from forming.

Cleaning the pump

The washing machine is fitted with a self-cleaning pump which does not require any maintenance. Sometimes, small items (such as coins or buttons) may fall into the protective pre-chamber at the base of the pump.

! Make sure the wash cycle has finished and unplug the appliance.

To access the pre-chamber:

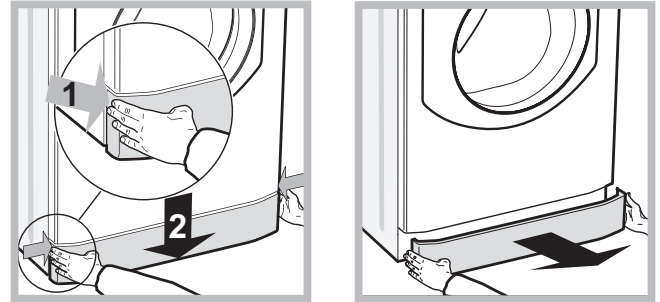

1. take off the cover panel on the front of the machine by first pressing it in the centre and then pushing downwards on both sides until you can remove it (see figures);

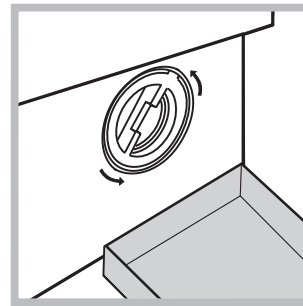

2. position a container so that it will collect the water which flows out (approximately 1.5 l) (see figure);

3. unscrew the lid by rotating it in an anti-clockwise direction (see figure);

4. clean the inside thoroughly;

5. screw the lid back on;

6. reposition the panel, making sure the hooks are securely in place before you push it onto the appliance.

Checking the water inlet hose

Check the inlet hose at least once a year. If there are any cracks, it should be replaced immediately: during the wash cycles, water pressure is very strong and a cracked hose could easily split open.

Your washing machine could occasionally fail to work. Before contacting the Technical Assistance Centre (see "Assistance"), make sure that the problem cannot be not solved easily using the following list.

Problem

The machine does not switch on.

The wash cycle does not start.

The machine does not fill with water or Indicator light for the first wash cycle flashing rapidly.

The machine continuously fills with water and continually drains away or Water left in the drum or Stuck on wash.

The machine does not drain or spin - (error lights flashing).

The machine does not spin.

The machine does not drain or spin.

The programme takes too long.

The Display sticks at one 'time to end' for more than 1 Minute or the Display changes the estimated 'Time to End' during the programme.

The machine vibrates a lot during the spin cycle.

Possible causes/Solution:

- The appliance is not plugged into the socket fully, or not enough to make contact.
- There is no power to the socket, or the fuse has blown in the mains plug.
- The door is not closed properly.
- The 'ON/OFF' button has not been pressed.
- The 'START/PAUSE' button has not been pressed.
- The water tap has not been turned on to allow water to flow into the machine.
- A delayed start has been set.
- The 'CHILD LOCK' is activated (see 'The machine just 'beeps' when a programme or option is selected' below).
- The water inlet hose is kinked.
- The water inlet hose is not connected to the water supply.
- The water pressure is too low.
- The water tap has not been turned on to allow water to flow into the machine.
- There is no water supply to the house.
- The inlet valve filter is blocked.
- The 'START/PAUSE' button has not been pressed.
- The top of the drain hose is too low - It must be fitted at a height between 65 and 100 cm from the floor.
- The drain hose is connected incorrectly to the sink trap allowing water to run into the machine, the drain hose must be positioned higher than the bottom of the sink to prevent water flowing down the drain hose.
- The end of the drain hose has been pushed too far down the standpipe, the 'U' bracket should be fitted 100 mm from the end of the drain hose.
- The Pump filter is blocked.
- The drain hose is kinked.
- *New Installation* - The blanking cap or spigot has not been removed if connected under a sink.
- The drain hose or sink trap is blocked.
- The Spin Speed is set to "00" position.
- The 'BABY' program has been selected, at the end of the program the machine drum will rotate slowly. To complete the wash cycle press the 'START/PAUSE'.
- The 'SILK' program is selected, at the end of the program it requires the drain phase to be started. To complete the program press either the 'START/PAUSE'.
- Programme times will vary due to water pressure, the incoming water temperature and if the wash load goes out of balance. This will increase the programme times accordingly (see 'The machine wont spin properly' below).
- The display time is for guidance only - ***it is not a precise time to finish and may vary.***
- The feet have not been adjusted, enabling the machine to rock.
- *New Installation* - Either the Transit Bolts including the plastic spacers, or the Polystyrene Packaging have not been removed when installing the machine.
- The machine is trapped between cabinets and/or walls.
- The load is in a slight out of balance condition and machine is spinning, but at a lower speed.

The machine is noisy.

- There will always be some motor, pump and drum noise during spin.

The machine wont spin properly.

- Out of Balance detected when attempting to go into a spin cycle - If this happens the machine will continue to try to repeat the distribution of the load required before the machine will go into higher spin speeds - This will increase the programme time accordingly. This is a safety feature to prevent damage. Out of Balance can be caused by washing a single heavy item (eg duvet, quilt, etc). - Try the programme again using a different load.

The machine leaks from the dispenser.

- The dispenser drawer is blocked with detergent and requires cleaning.
- The water pressure is too high and requires turning down - turn down the tap on the water supply pipe slightly and try again.
- The machine is tilting forwards - It must be level when in its final position.

The machine leaks (other than dispenser).

- The fill hose is loose, check both the cabinet and tap ends.
- The fill hose is tight but still leaks, if so replace the rubber washers, or the fill hose is missing the rubber washer.
- The drain hose is not fixed in properly.

The Phase in Progress indicator lights flash rapidly at the same time as the ON/OFF indicator light.

- Switch off the machine and unplug it, wait for approximately 1 minute and then switch it back on again If the problem persists contact the Technical Assistance Service.

The machine smells.

- The machine requires a service wash. Run a 90 degree wash cycle with detergent and no laundry.

The machine door cannot be opened.

- The door will not open until the door lock indicator light goes out shortly after the program has finished.
- If there is no power to the machine you need to perform the manual unlocking procedure.

Door Seal damaged at the bottom.

- The door seal has drainage holes at the bottom - This is normal.

The water level is too low when the machine is washing.

- The water level is correct if it can be seen at the bottom of the door.

The word 'dON' appears intermittently in the display window and the drum slowly turns.

- To exit, switch machine off, then press and hold 'ON/OFF' and 'START/PAUSE' buttons simultaneously for 3 seconds Note the machine will need the language resetting.

The machine just 'beeps' when a programme or option is selected (Child Lock Symbol is lit).

- Deactivate the Child Lock feature by pressing and holding in the 'CHILD LOCK' button for 2 seconds.

There is too much foam.

- The detergent is not suitable for machine washing (it should display the text 'for washing machines' or 'hand and machine wash' or the like).
- Too much detergent was used - less detergent is required in soft water.

After completing the programme, or before starting a programme, the machine has turned itself off (no lights).

- To comply with new energy saving regulations the machine is fitted with an automatic standby system. Press 'ON/OFF' button for 3 seconds to activate the machine, it can then either be switched off or a new programme selected.

General.

- Your washing machine contains sensors that monitor progress during the wash cycle (eg: Water Levels, Temperatures, Out of Balance loads, Wash time/progress). Normally, if your machine successfully completes the cycle, there is unlikely to be anything wrong!

Troubleshooting:

The machine's washing performance is unsatisfactory.

Possible causes / Solutions:

- The tanks have not been loaded correctly (e.g. fabric softener has been added instead of detergent or vice-versa)
- Two different types of detergent/fabric softener have mixed.
! NEVER mix two different detergents; always clean out the tanks before adding a new type of detergent.
- The "Auto Dose System" is blocked due to prolonged lack of use: carry out a tank cleaning cycle (refer to "Cleaning cycle pre-set by user").

What happens if the tanks are loaded even if they are already full?

- Buzzers (Beep) and visual signals (icons appearing on the display) indicate that the tank is full. If further detergent/fabric softener is added, the excess quantity will fall into the drum and will be washed away with the next cycle.

What happens if the dispenser is used in the traditional mode while the tanks are still full?

- The machine will automatically track whether powder or liquid detergent has been loaded in the traditional mode and will not intake any amount of detergent from the tank. Fabric softener can only be used in the "Auto Dose System" mode.

Can the tanks also be used for powder detergent?

- No, powder detergent can only be used in the traditional mode.

Can powder detergent fall into the tanks?

- No, there is a barrier to prevent powder detergent from falling into one of the tanks even if the dispenser is open in the "Auto Dose System" position (i.e. completely open).

What happens if the dispenser is not opened properly when filling the tanks?

- If the dispenser is not completely open, the detergent or fabric softener that has been added will fall into the drum and will be washed away with the next cycle.

What happens if detergent and fabric softener are erroneously inverted?

- The washing machine will wash with unsatisfactory results, the tanks will have to be emptied and subjected to a manual cleaning cycle.

What happens if different detergents are mixed before the tanks are empty?

- The machine will wash normally although we recommend only refilling the tanks after the signal emitted by the machine; do not mix different detergents/fabric softeners.

Remember, you will be charged for a service call for problems caused by incorrect installation, as listed above.

Not emptying contents from pockets may cause pump or drain blockages, or may damage the machine. Do not wash items which do not have a wash label, or wash items that are not intended as machine washable.

Guarantee

12 Months Parts and Labour Guarantee

Your appliance has the benefit of our manufacturer's guarantee, which covers the cost of breakdown repairs for twelve months from the date of purchase.

This gives you the reassurance that if, within that time, your appliance is proven to be defective because of either workmanship or materials, we will, at our discretion, either repair or replace the appliance at no cost to you.

This guarantee is subject to the following conditions:

- The appliance has been installed and operated correctly and in accordance with our operating and maintenance instructions.
- The appliance is used only on the electricity or gas supply printed on the rating plate.
- The appliance has been used for normal domestic purposes only.
- The appliance has not been altered, serviced, maintained, dismantled, or otherwise interfered with by any person not authorised by us.
- Any repair work must be undertaken by us or our appointed agent.
- Any parts removed during repair work or any appliance that is replaced become our property.
- The appliance is used in the United Kingdom or Republic of Ireland.

The guarantee **does not cover:**

- Damage resulting from transportation, improper use, neglect or interference or as a result of improper installation.
- Replacement of any consumable item or accessory. These include but are not limited to: plugs, cables, batteries, light bulbs, fluorescent tubes and starters, covers and filters.
- Replacement of any removable parts made of glass or plastic.

THIS GUARANTEE WILL NOT APPLY IF THE APPLIANCE HAS BEEN USED IN COMMERCIAL OR NON-DOMESTIC PREMISES.

5 Year Parts Guarantee

Hotpoint also offers you a free 5 year parts guarantee. This additional guarantee is conditional on you registering your appliance with us and the parts being fitted by one of our authorised engineers.

There will be a charge for our engineer's time. To activate the extra parts warranty on your appliance, simply call our registration line on **08448 24 24 24 (ROI 01 230 0800)**.

Extended Guarantees

We offer a selection of repair protection plans that enable you to fully cover yourself against the expense of repair bills for the life of your policy. To find the ideal plan for you please call our advice line on **08448 226 226 (Republic of Ireland 01 230 0233)**.

Free Helpdesk Service

We have a dedicated team who can provide free advice and assistance with your appliance if you experience any technical difficulties within the first 90 days of ownership. Simply call our Hotpoint Service Hotline on **08448 224 224 (Republic of Ireland 0818 313 413)** for telephone assistance, or, where necessary, to arrange for an engineer to call. If we cannot resolve the technical problem we will replace your machine or, if you prefer, give you your money back.

After Sales Service

No one is better placed to care for your Hotpoint appliance during the course of its working life than us - the manufacturer.

Essential Contact Information

Hotpoint Service

We are the largest service team in Europe offering you access to 400 skilled telephone advisors and 1000 fully qualified engineers on call to ensure you receive fast, reliable, local service.

UK: 08448 224 224
Republic of Ireland: 0818 313 413
www.hotpointservice.co.uk

Please note: Our advisors will require the following information:

Model number:

Serial number:

Parts and Accessories

We supply a full range of genuine replacement parts as well as accessory products that protect and hygienically clean your appliance to keep it looking good and functioning efficiently throughout its life.

UK: 08448 225 225
Republic of Ireland: 0818 313 413
www.hotpointservice.co.uk

Appliance Registration

We want to give you additional benefits of Hotpoint ownership. To activate your free 5 year parts guarantee you must register your appliance with us.

UK: 08448 24 24 24
Republic of Ireland: 01 230 0800
www.hotpointservice.co.uk

Indesit Company UK Ltd. Morley Way, Peterborough, PE2 9JB

Indesit Company Unit 49 Airways Industrial Estate, Dublin 17



Recycling & Disposal Information

As part of Hotpoint's continued commitment to helping the environment, Hotpoint reserves the right to use quality, recycled components to keep down customer costs and minimise material wastage.

Please dispose of packaging and old appliances carefully. To minimise the risk of injury to children, remove the door, plug and cut the mains cable off flush with the appliance. Dispose of these parts

